

OSCAR

Solar air collector

Catalogue

Function, Product, Advantage, Tips, About Oscar

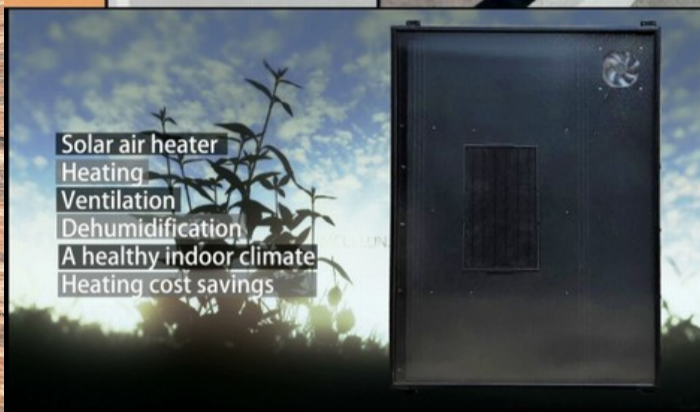

Function introduction

The sun shines on the special heating absorption board and the surrounding air absorbs heat. OSCAR solar air collector/ heater takes in air at the bottom of panels, and through a special construction, the air is heated in the sun catching the most heat and then delivered into the room. The heated fresh air is blown into the house by a fan, driven by photovoltaic panel.

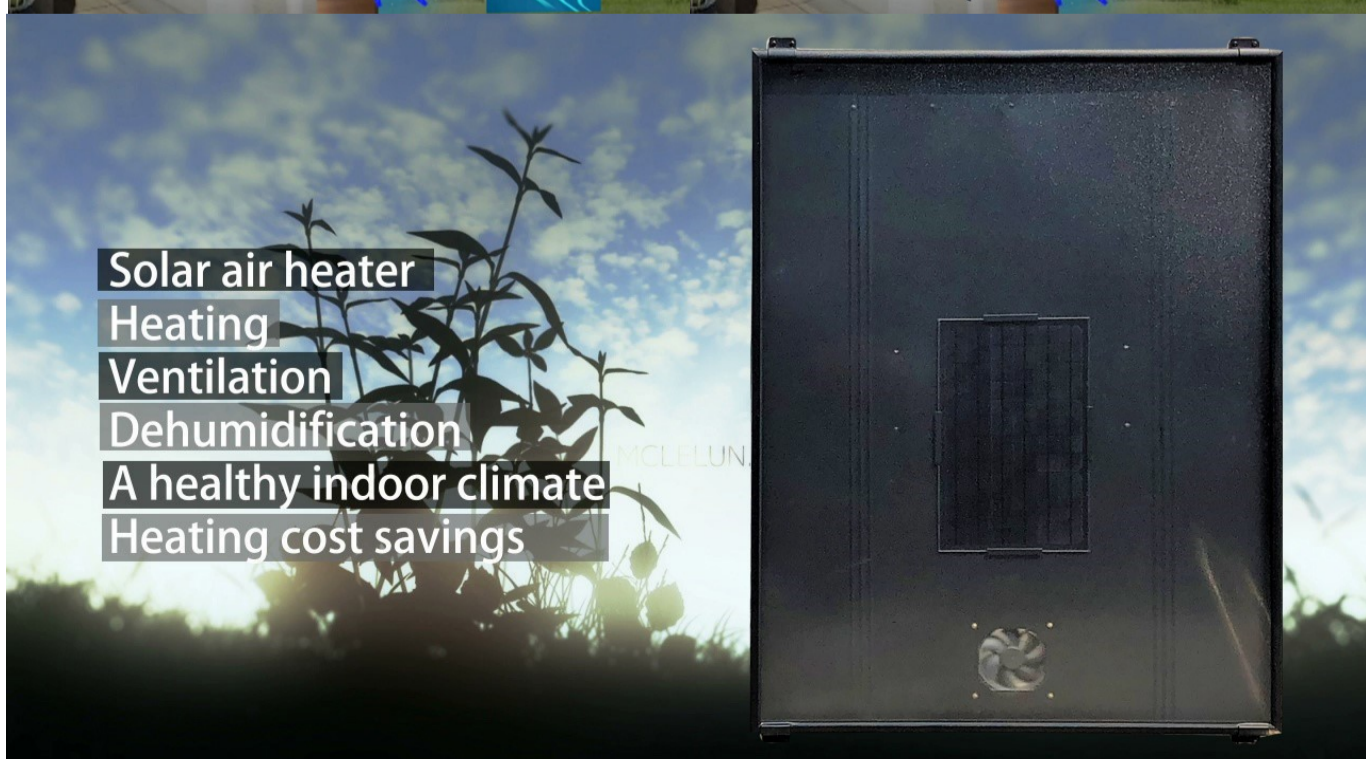
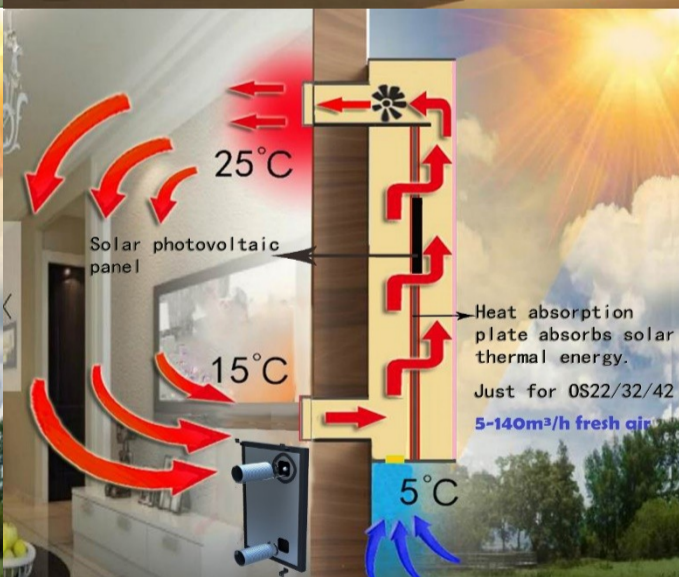
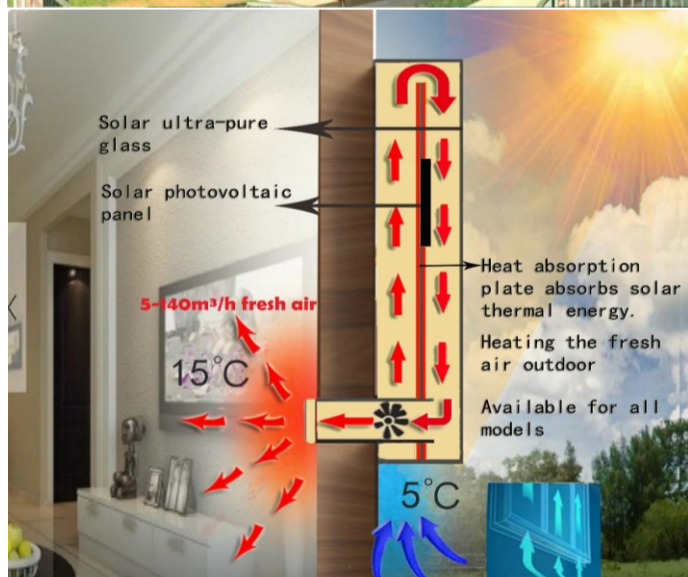
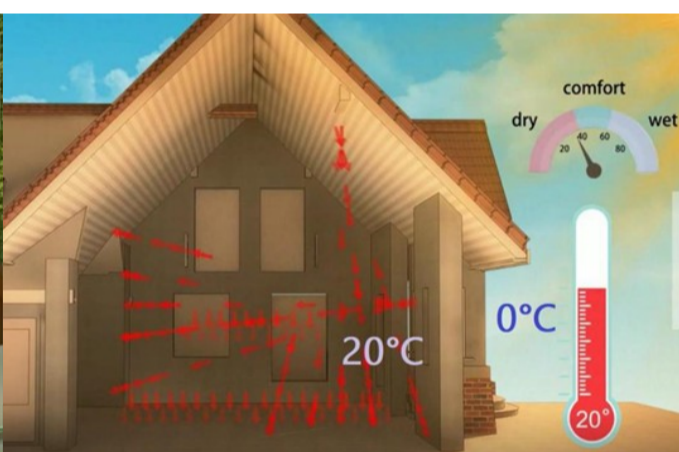

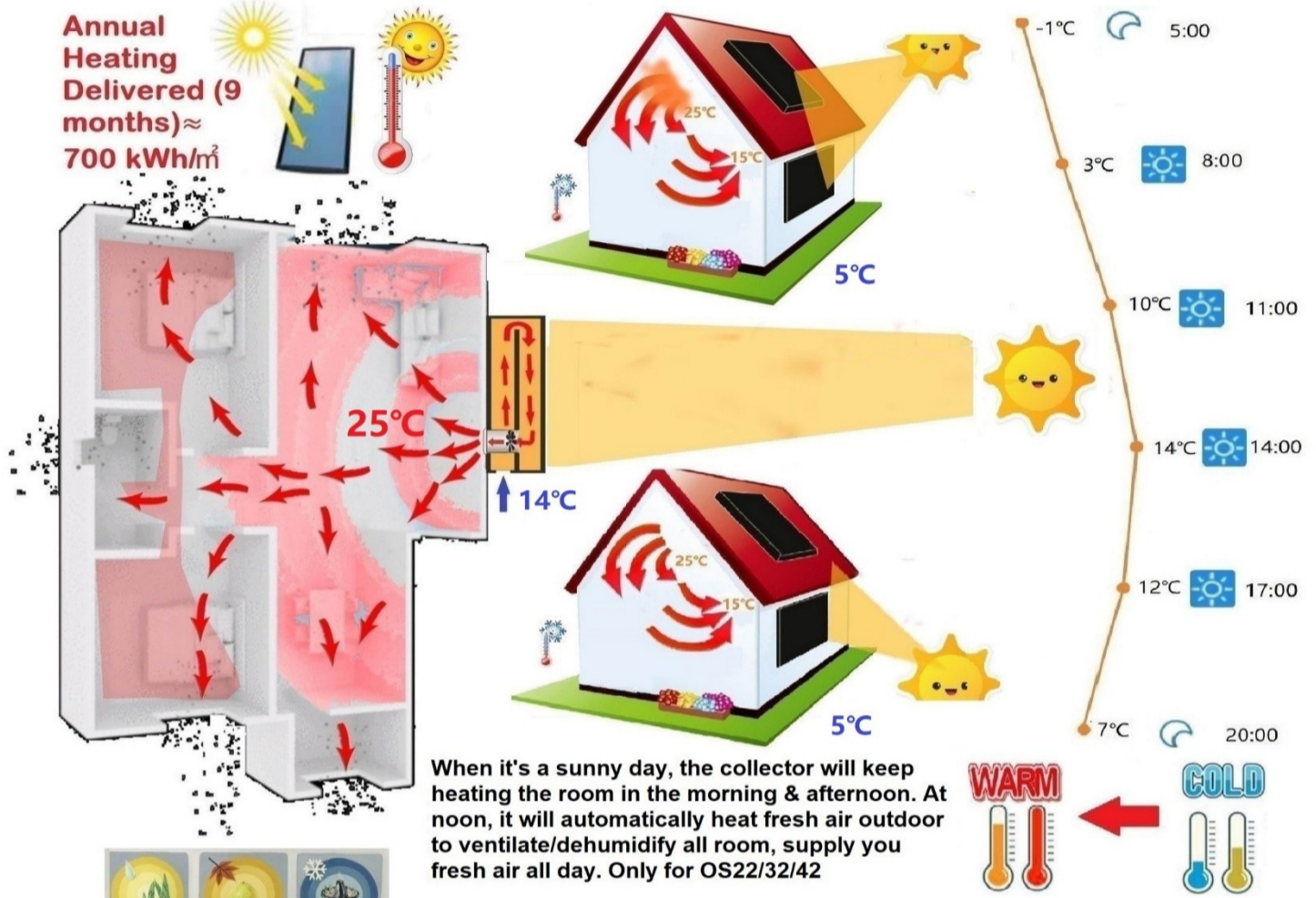

Automatic ventilation when outdoor temperature is higher than indoor temperature.

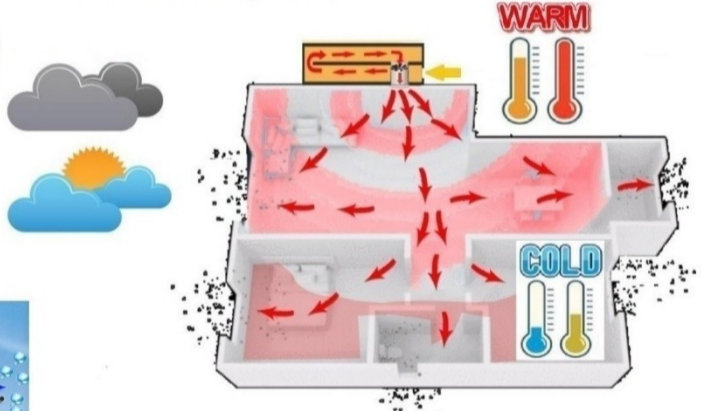

Ventilation for 1-3h, when the outdoor temperature reaches its highest level at noon in spring / autumn / winter.

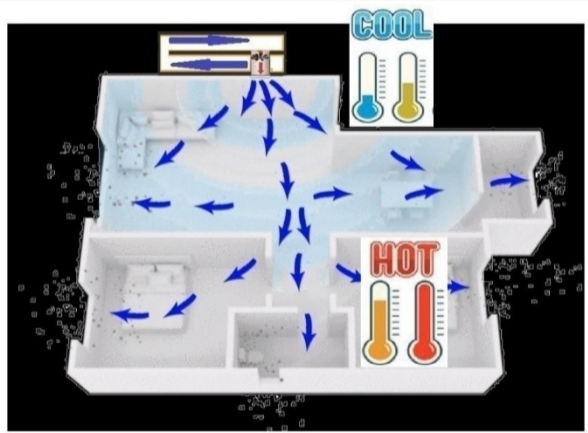
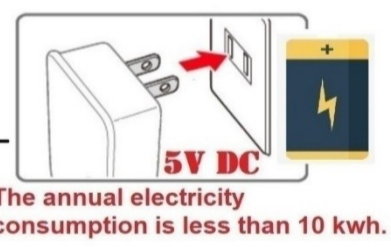
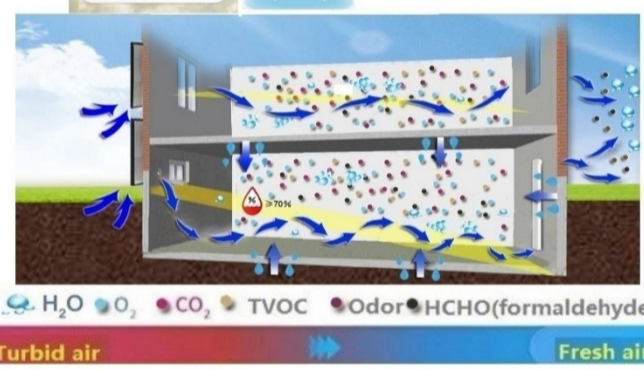

Automatic ventilation when outdoor temperature is lower than indoor

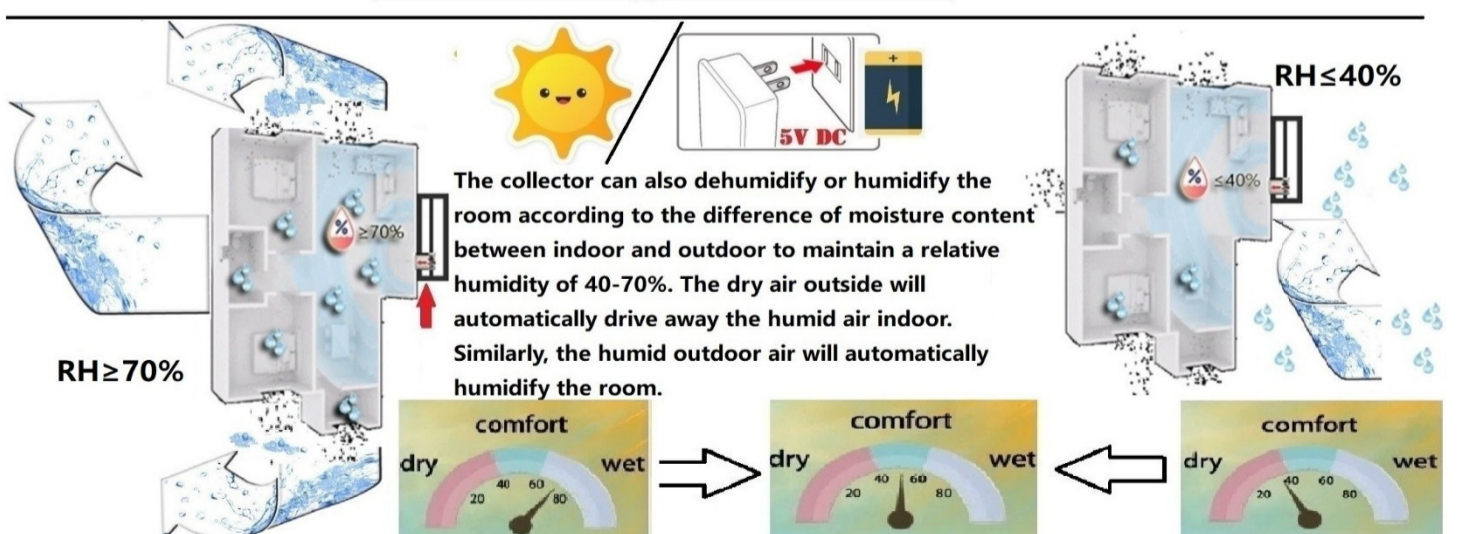

Ventilation, heating, dehumidification or humidification. Solar collector with LCD thermostat, provides you with a healthy and warm home and automatically processes indoor air. Simple operation, thoughtful air management expert!

OSCAR solar air collectors always provide you with a warm and healthy home

When it's a sunny day, the collector will keep heating the room in the morning & afternoon. At noon, it will automatically heat fresh air outdoor to ventilate/dehumidify all room, supply you fresh air all day. This function is only applicable for OS22/32/42. Ventilation can be extended at noon in spring / autumn.

Even in rainy or cloudy weather, the collector will provide fresh air to you by automatically switching to electricity, and the power consumption is less than 10kWh per year. When the outdoor temperature reaches its highest level at noon in spring / autumn / winter, or when the weather is cool in the summer evenings, it will ventilate the room to improve the indoor temperature; keep you warm in winter and cool in summer. The collector can also dehumidify or humidify the room according to the difference of moisture content between indoor and outdoor to maintain a relative humidity of 40-70%. The dry air outside will automatically drive away the humid air indoor. Similarly, the humid outdoor air will automatically humidify the room.

Heating

The built-in solar powered fan makes air transport which results in a contribution to heat the building and thus a saving on heating bills. Regular ventilation without power consumption. On a sunny day, the temperature of the injected air is approximately 5-40°C higher than the outdoor or indoor air inlet temperature. In addition, the outdoor temperature at noon rose by several degrees Celsius.

Ventilation

The fresh air of solar air heater squeezes the turbid air out of the room, keeping the air fresh and oxygen-rich.

Depending on the models, approx. 5 to 140m³/h dry, warm air is blew into the room. In the case of cloudy days without sunlight, the room can also be properly ventilated. Humid air is drove out of the room through a built-in valve or the cracks and crevices of the building.

Ventilation is a key factor to the state of every building. Stagnant indoor air increases the risk of fungi, rot and other unwanted consequences.

Preserve the value of your vacation home while getting fresh air – for free and all year round!



Fresh air of Solar air heater squeezes the turbid air out of the room, keeping the air fresh and oxygen-rich.
Ventilation design standard: minimum fresh air volume per capita: 30m³/h.

FRESH OXYGEN

Increase oxygen, reduce CO₂, and care for health, do not feel oppressed.

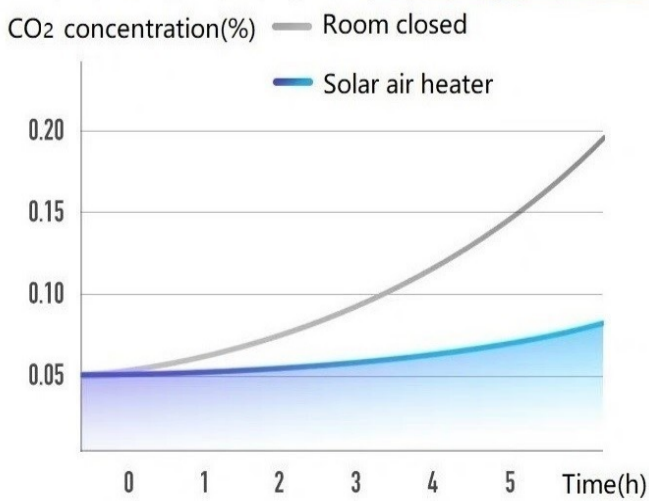

CO₂ concentration rise comparison chart
 An adult is tested in a 15m² closed room for 6 hours

Dehumidification or humidification

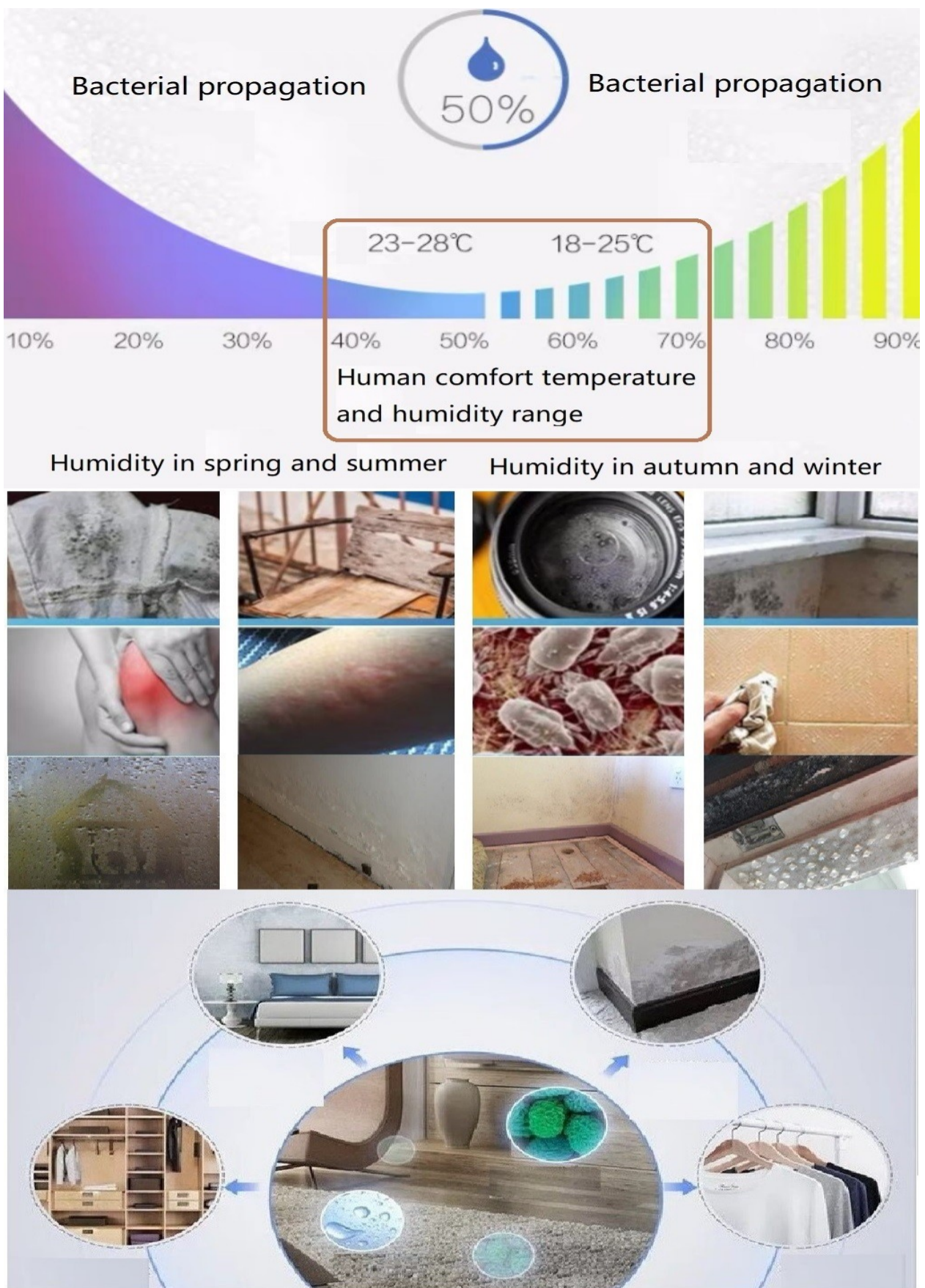

Optimum level (for comfort as well as building quality) is a relative humidity (RH) of 40-70 %.

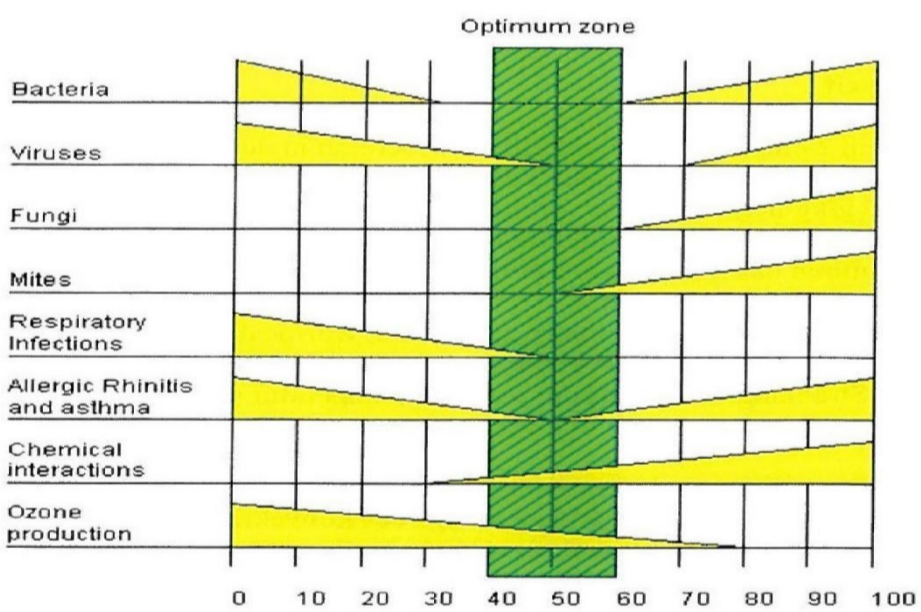

Source: ASHRAE Journal (The American Society of Heating, Refrigerating and Air-Conditioning Engineers)

The OSCAR solar air heater in the basement can fully solve the moisture in the basement and extend the service life of the indoor structure and appliances. Basement problem: damp basement. One of the earliest signs of wetness in the basement was a stale smell. Humidity can quickly damage items stored in the basement, such as textiles, cardboard boxes or furniture. In addition, lack of regular ventilation can cause mold and harmful fungi. To make the room suitable again, it must be regularly heated, mechanically dehumidified and ventilated. Electric dehumidifiers will frost below 15 °C, so the dehumidification effect will be worse. In addition, the dehumidifier requires refrigeration and consumes a large amount of power. This often results in high operating costs.



The dry climate indoor can easily cause virus and bacteria to multiply and spread. In addition, the dry air takes away water from the body, making them feel dry, feverish, depressed, coughing, hoarse, and sore throat.

● **A healthy and fresh indoor climate**

Improve the indoor environment, reduce the irritation caused by allergy and asthma, especially for newborns. Improvement on the dwelling atmosphere---- bring in oxygen and reduce carbon dioxide; discharge unpleasant odors which might cause allergies and discomfort; control the temperature and moisture of the room, prevent the emergence and spread of bacteria. When dry and warm air keeps flowing in the room, the damp, rot or mold would be long-term reduced.

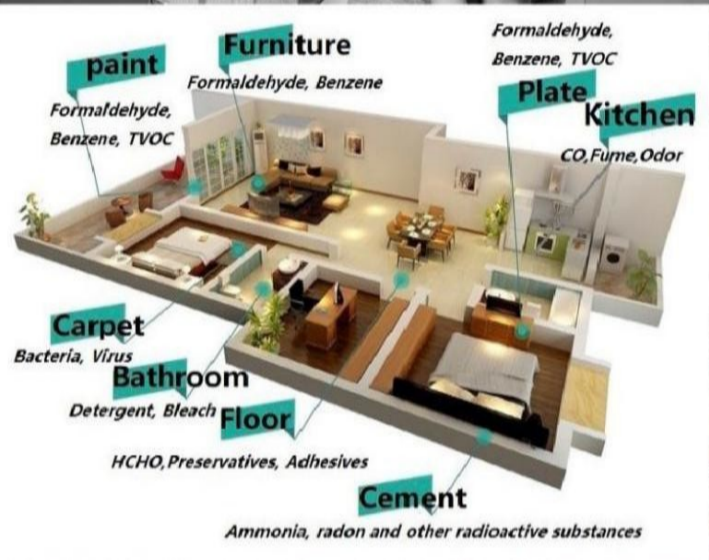
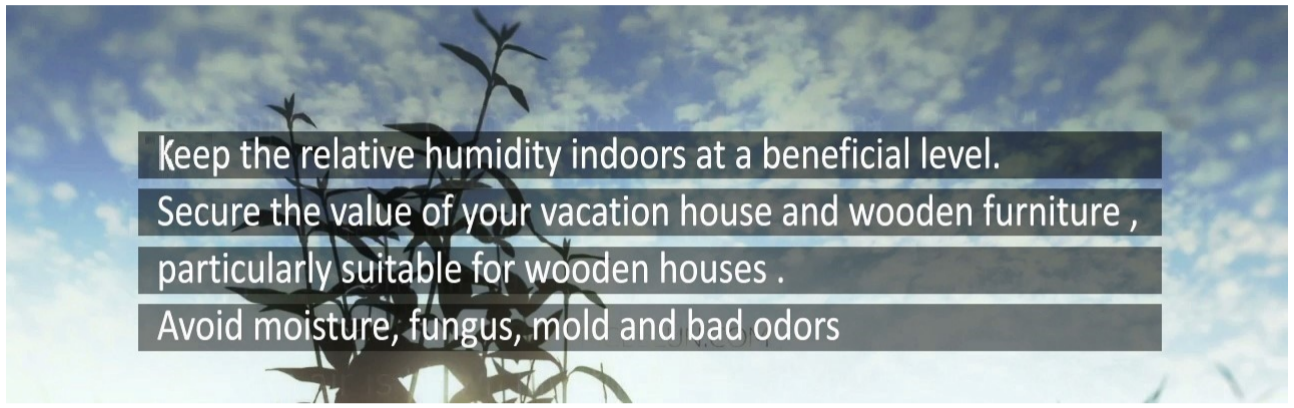

WHO (World Health Organization) lists indoor air pollution as one of the top 10 threats to human health. When indoor ventilation conditions are poor, gas pollutants will accumulate indoors, and the concentration will increase, causing serious indoor air pollution.

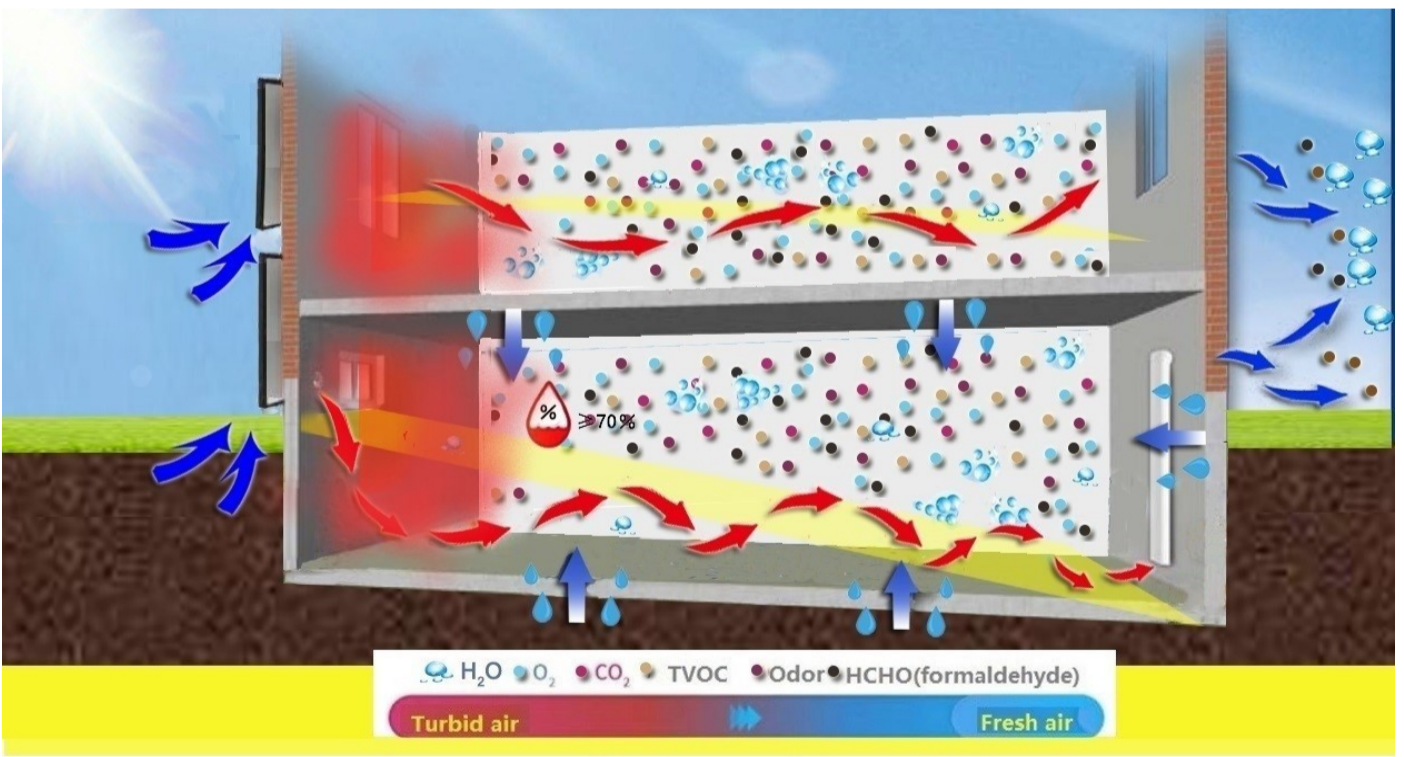

Heating + ventilation = dehumidification
Hot air absorbs moisture from the room and discharges it.

● **Get your money back in 2-3years**

Total Annual Heating Delivered (9 months) kWh/m² is about 700 kWh/m².

● **Free cost**

Ventilating and heating with no costs! Decrease your heating bills significantly!
 No running costs.

● **Environment friendliness**

Reduce the amount of air pollution and greenhouse gases that result from the use of fossil fuels for heating.

● **Safety**

Low voltage, no fire, no household electricity, no smoke or dust.

OSCAR solar air collectors always provide you with a warm and healthy home

Applications
 in holiday cabins
 in residential and commercial buildings
 in the cottages and summer residences
 in caravans and tents
 in conservatories
 in cellars and storage areas
 in football and other sports cabins
 in areas without electrification



Product Information

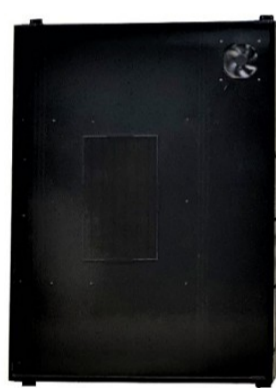

OS32



OS30



OS22

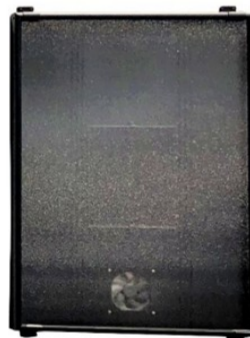

OS20



OS10



OS40



OS42

OS10/OS20/OS30/OS40:

Heating outdoor fresh air: available in spring, autumn and winter.

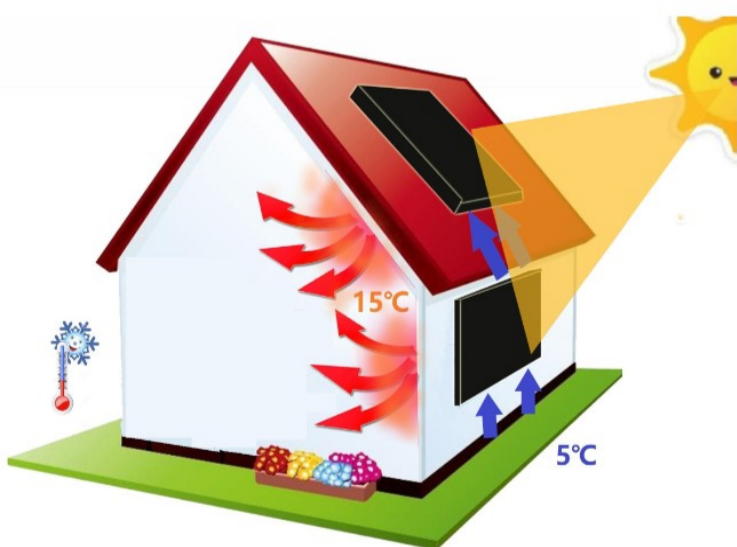

OS22/OS32/OS42: 2-in-1 function

Heating outdoor fresh air: suitable for all models.

Heating indoor air circularly mold: can keep heating the room air and increasing the room temperature, and can keep away from any wet or cold or smog air. This mode is the best way to heat the room. Applicable to OS22/32/42.

When the outdoor temperature is too low, just open the air inlet indoor to keep heating the indoor air. Just close the air inlet indoor to introduce and heat the fresh air outdoor.

OSCAR solar air collectors always provide you with a warm and healthy home

Product detail for aluminum alloy heater

Model	OS10	OS10H	OS20	OS22	OS30	OS32	OS40	OS42
Appro room area	15m ²	20 m ²	40m ²		60m ²		90m ²	
Maximum air volume	42m ³ /h	88m ³ / h	88m ³ / h	98m ³ / h	105m ³ / h	113m ³ /h	128m ³ /h	135m ³ /h
Time for air change	Approximate 2 hours							
Heating efficiency	69%	77%	73%	77%	70%	74%	69%	72%
Sun intensity performance (w/h/set)	265W	300W	520W	550W	800W	840W	1310W	1380W
Total Annual heat supply kWh/m ²	690	770	730	770	700	740	690	720
Estimated energy supplement year	250kWh	280kWh	525kWh	550kWh	777kWh	820kWh	1359kWh	1418kWh
Temperature rise approx.	8° C	5° C	15° C	16° C	25° C	26° C	30° C	32° C
Dehumidification capacity (high humidity)			0.3L/hour		0.5L/hour		0.8L/hour	
Noise level	39db	45db	45db		48db		50db	
Product size (cm)	71x52x6.2	52x71x6.2	101x72x6.2		121x92x6.2		197x100x6.2	
Carton size(cm)	90x57x9	57x90x9	124x78x9		129x98x9		204x106x9	
Roof mounting kit	Not applicable				120x17 x12cm 8.2kg		112x28x16cm 12kg	
Product area	0.37 m ²	0.37 m ²	0.72 m ²		1.11 m ²		1.97 m ²	
Solar photovoltaic panel power	8watt	12watt	12watt		18watt		28 watt	
Fan 2 ball	12V 3.6W 92*92*25mm	SUNON 12V, 3.4 watt 120*120*25mm					SUNON 12V, 5.4 watt 120*120*25mm	
Net weight	9kg	9kg	17kg		25kg		37kg	
Gross Weight	10kg	10kg	18kg	19kg	28kg	29kg	39kg	40kg
Special heating absorption board	Special anodic aluminum oxide, texture nano heat insulation coating, high absorption, low reflection.							
Frame	Exclusively for open air, anti-UV texture coating aluminum alloy							
Coating	Low iron patterned solar tempered glass, up to 92% transmittance							
	White diffuser Flange for indoor wall; Tubes for wall lead-in, gaskets, screws etc.							

The price includes a mechanical thermostat and all necessary mounting accessories. Extra cost will be charged if customer needs LCD thermostat and automatic air outlet.

Reducing the air volume can increase the air temperature into the room. Increasing the air volume can increase the heating efficiency and dehumidification effect.

When used in basement and other high humidity environment. It is recommended to buy a larger model, which have stronger capacity for dehumidification, deodorization, removal of formaldehyde and hydrazine.



OS10H+F7



OS20+F7



OS32+F11



OS22+F7

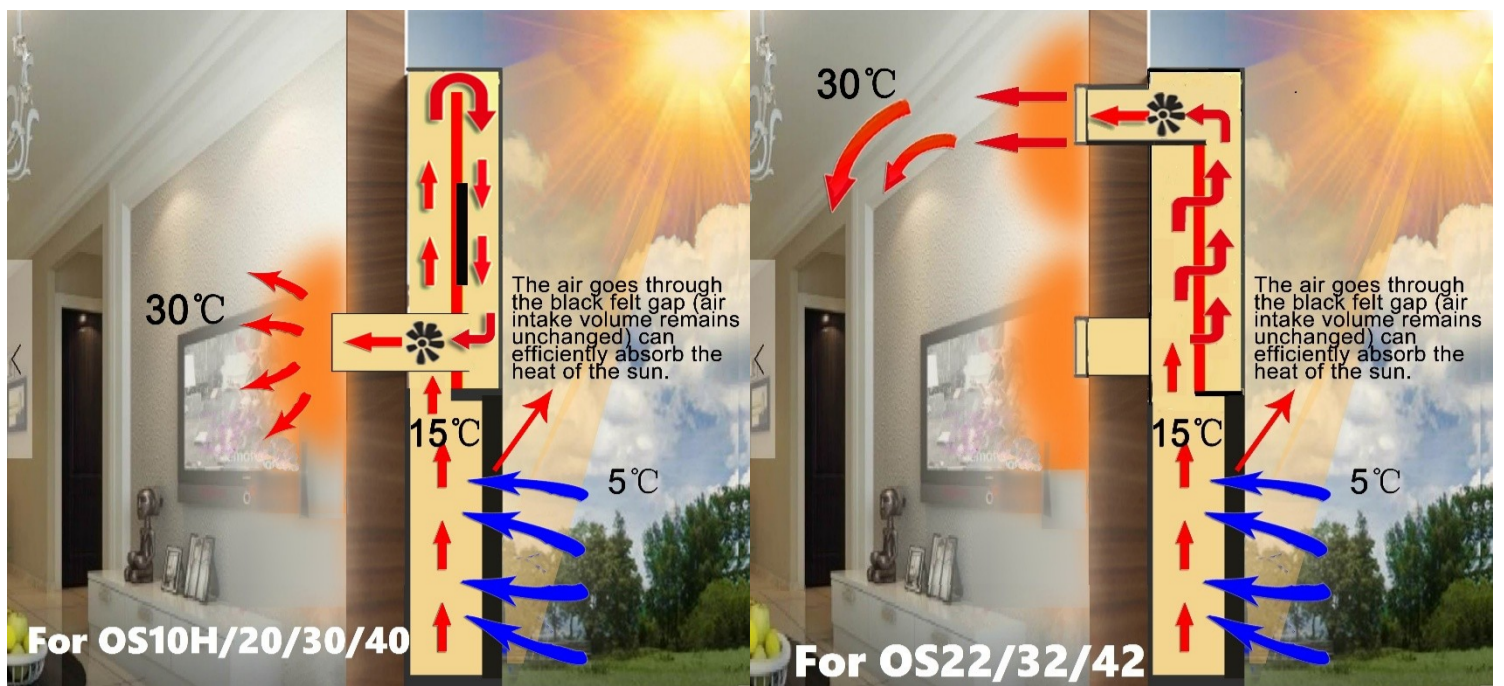

The special felt cover can be spliced with aluminum alloy collector (OS10H/20/22/30/32) and installed on a flat roof or wall. The air through the black felt gap (air intake volume remains unchanged) can efficiently absorb the heat of the sun, thereby increasing the temperature of the outdoor fresh air entering the room. As long as the felt cover is spliced, the temperature of the fresh air entering the room can be increased: F7----about 10°C; F11----about 15°C.

After a long period of outdoor dust and rain test, the air intake volume is reduced by up to 3%. It can effectively filter Dust and become clean after rain washing, no maintenance is required. The service life is more than 5 years.

Felt cover	F7 for OS20/22	F11 for OS30/32	F11H(horizontal) Just for OS32
Can't be used alone			
Appro temperature rise	15° C	25° C	25° C
Max performance(w/h)	520W	800W	800W
Estimated energy supplement	525kwh/unit/year	770kwh/unit/year	770kwh/unit/year
Product area	0.7 m ²	1.1 m ²	1.1 m ²
Product size(cm)	101x72x6	121x92x6	92x121x6
Carton size(cm)	101x10x10	118x12x12	118x12x12
Net weight	2KG	3KG	3KG
Gross Weight	3KG	4KG	4KG

Introduction and images for regulators or switches



Mechanical thermostat:

The standard configuration can only work in the sun, and cannot be connected to electricity.

Ventilator will stop working when the room temperature reaches the set value (eg. 25°C).

New LCD thermostat: Ventilation and dehumidification or humidification are available even on cloudy or summer nights. Smart curved touch screen: the perfect combination of art and technology!

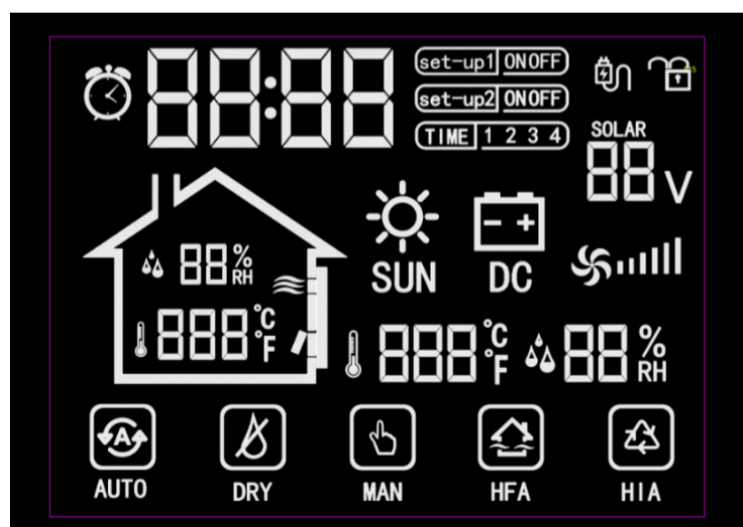

Ventilation, heating, dehumidification or humidification. Solar collector with LCD thermostat, provides you with a healthy climate and automatically processes indoor air. Simple operation, thoughtful air management expert!

OSCAR solar air collectors always provide you with a warm and healthy home

There are five modes: automatic, humidity control, manual, heating and ventilation, continuous heating of indoor air. Can detect indoor and outdoor temperature and humidity, moisture content in the air. Automatically switch between solar and electrical energy. Ventilate regularly to purify the air every day. As long as the collector does not work, the air vents automatically close, completely isolating the outdoor cold air.

Heating in the sun in the spring/ fall/ winter			
LCD Thermostat	When presetting temperature is higher than indoor temperature.		
Automatic mode	Sunshine-12am	12:00 am--- 3:00 pm	3pm--no Sunshine
Only for OS22/32/42	Keep heating indoor air circularly	Heating outdoor fresh air (Spring and autumn can increase ventilation time)	Keep heating indoor air circularly
For OS20/30/40	Just heating outdoor fresh air in the sun		
In the process of heating indoor air, if the following conditions occur, the device will automatically turn to heat the outdoor fresh air.			
1. Outdoor air (moisture content) is dryer than indoor		and indoor relative humidity $\geq 75\%$	
2. Outdoor air is wetter than indoor air		and Indoor relative humidity $\leq 30\%$	
3. When it is detected that the outdoor temperature is higher than the indoor temperature.			
Humidity control mode	Sunshine-11am	11am--- no sunshine	
Only for OS22/32/42	Keep heating indoor air circularly	Heating outdoor fresh air (Spring and autumn can increase ventilation time)	
For OS20/30/40	Just heating outdoor fresh air in the sun		
In the process of heating indoor air, if the following conditions occur, the device will automatically turn to heat the outdoor fresh air.			
1. Outdoor air (moisture content) is dryer than indoor		and Indoor relative humidity $\geq 70\%$ (60%-75%)	
2. Outdoor air is wetter than indoor		and Indoor relative humidity $\leq 40\%$ (30%-45%) ;	
3. When it is detected that the outdoor temperature is higher than the indoor temperature.			
In the process of ventilation, if the following conditions occur, the fan stops working.			
Outdoor air (moisture content) is wetter than indoor air		and indoor relative humidity $\geq 70\%$	
Manual mode	Can set a time period to heat fresh air or air indoor		
Heating fresh air mode	Just heating outdoor fresh air		
Heating indoor air mode	Keep heating indoor air circularly		
Electricity			
LCD Thermostat	All models can only introduce fresh outdoor air to regulate indoor temperature and humidity.		
Automatic mode	In the Spring/Fall/Winter	In the Summer	
Automatic ventilation	When outdoor temperature is higher than indoor.		When outdoor temperature is lower than indoor.
Ventilation 1-3h from 13pm, keep the room fresh.	Outdoor 5-15°C (adjustable)	Outdoor 15-23°C (adjustable)	Outdoor 23-28°C (adjustable)
	Ventilate for 1h	2 hours	3 hours
Outdoor air (moisture content) is dryer than indoor		and indoor relative humidity $\geq 85\%$	
Outdoor air (moisture content) is wetter than indoor		and indoor relative humidity $\leq 35\%$	
Will ventilate to regulate moisture content indoor			
In the process of ventilation, if the following conditions occur, the fan stops working.			
Outdoor air (moisture content) is dryer than indoor		and indoor relative humidity $\leq 35\%$	
Outdoor air (moisture content) is wetter than indoor		and indoor relative humidity $\geq 85\%$	
Humidity control mode: Indoor relative humidity adjustment range: 30% -45%; 60% -75%.			
Outdoor air (moisture content) is dryer than indoor		and indoor relative humidity $\geq 70\%$	
Outdoor air (moisture content) is wetter than indoor		and indoor relative humidity $\leq 40\%$	
Will ventilate to regulate moisture content indoor			
Manual mode	Can set 2 time periods freely to ventilation.		
Heating fresh air mode	In the Spring/Fall/Winter	In the Summer	
Automatic ventilation	When outdoor temperature is higher than indoor.		When outdoor temperature is lower than indoor.
Ventilation 1-3h from 13pm, keep the room fresh.	Outdoor 5-15°C (adjustable)	Outdoor 15-23°C (adjustable)	Outdoor 23-28°C (adjustable)
	Ventilate for 1h	2 hours	3 hours
Note: To obtain reasonable moisture, cold air may enter the room or sometimes prevent heating in the sun, such as excessive moisture after rain.			

Solar exhaust fan

A Ventilation Kit can be used as an exhauster for the humid air. An exhauster is necessary in the basement or other big buildings, which can't breathe or need extra ventilation. The exhauster will be working at the same time as the solar air collector. Louver outlet with automatic close function, will keep the room heat

from losing when fan turns off. Either electricity or solar energy is ok.

Max air volume: 160m³/h.

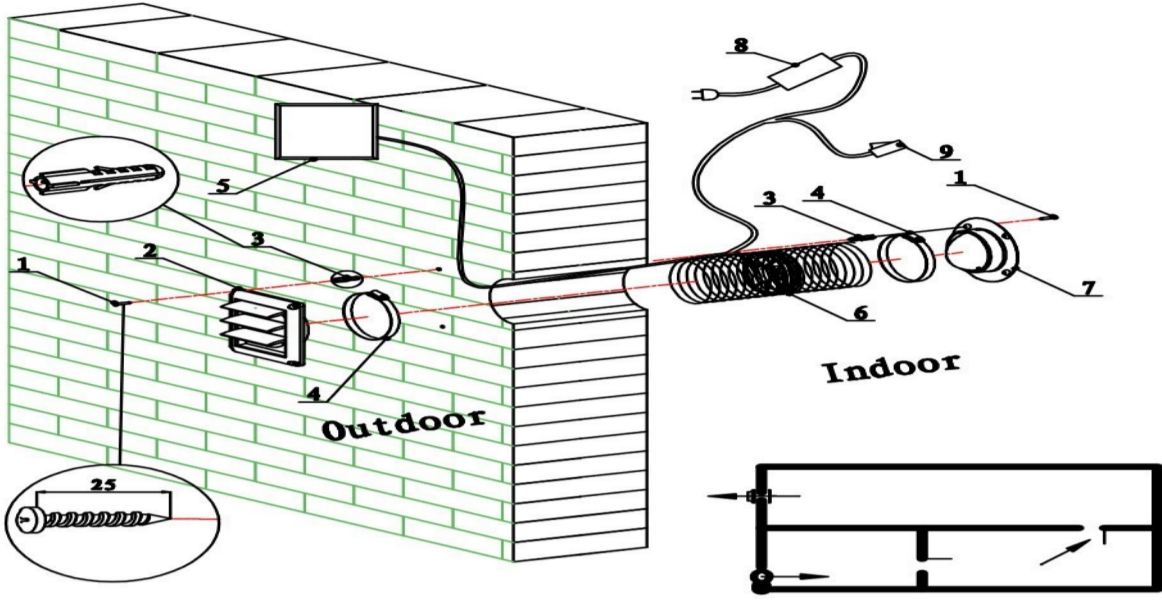

Including:

1 pc, Air outlet and Air inlet

1 pc, Diameter 125mm Telescopic duct

1 pc, 11W solar panel

1 pc, SUNON 125mm DC fan, Work time: 40000h

Technical reference

Best in comparison test



Solar Panel	Width (cm)	Height(cm)	Thickness (cm)	Effective area (m ²)	Weight (kg)	Fan (mm)
OS10	52	71	6.2	0.37	6	ADDA 92*92*25
OS32	92	121	6.2	1.11	20	SUNON120*120*25
OS30	92	121	6.2	1.11	20	SUNON120*120*25
OS22	72	100	6.2	0.72	13	SUNON120*120*25
OS20	72	100	6.2	0.72	13	SUNON120*120*25
SV7	70	100	5.5	0.7	8	SUNON120*120*25

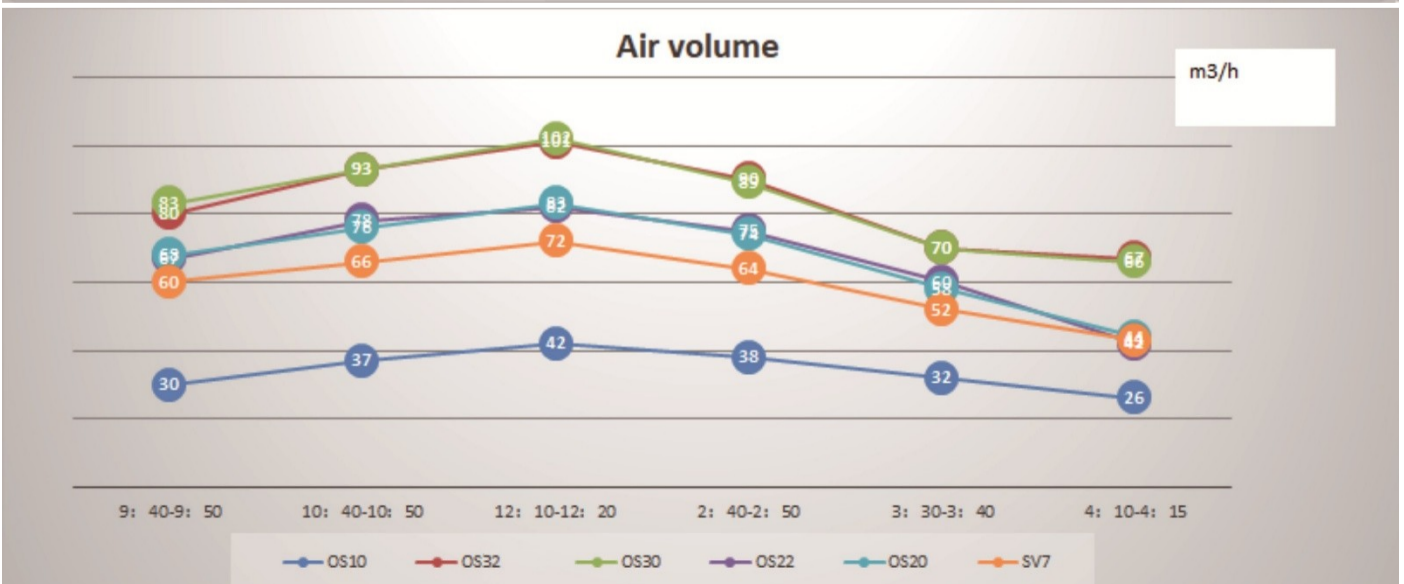
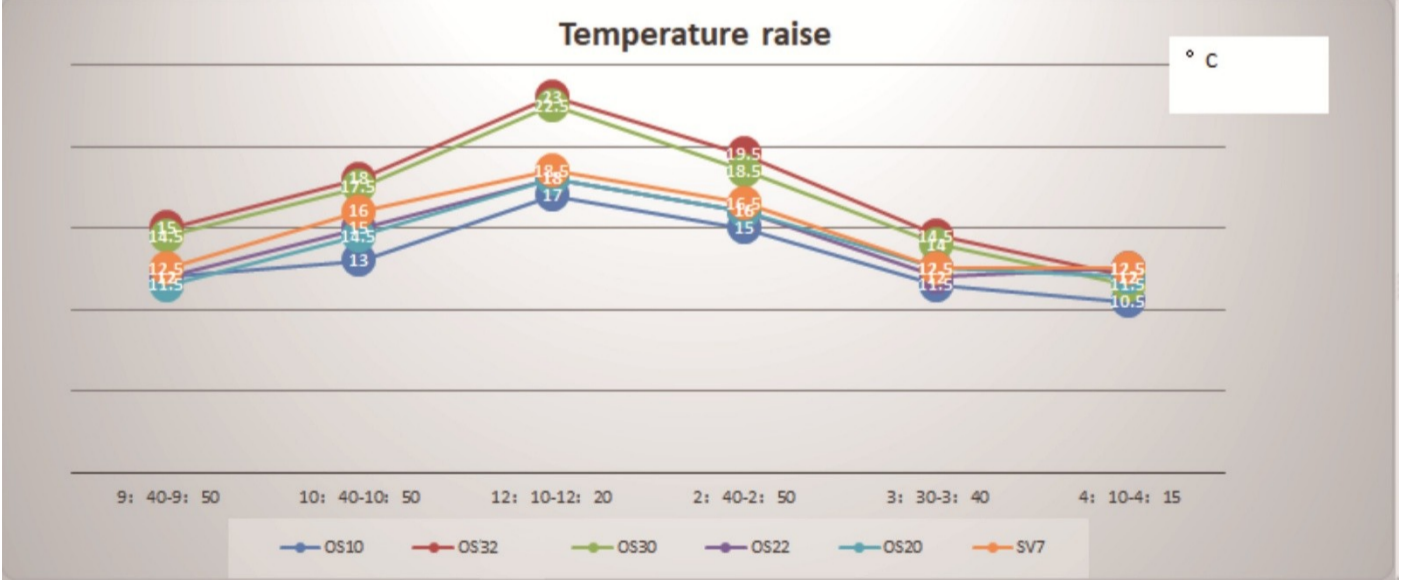

OSCAR solar air collectors always provide you with a warm and healthy home

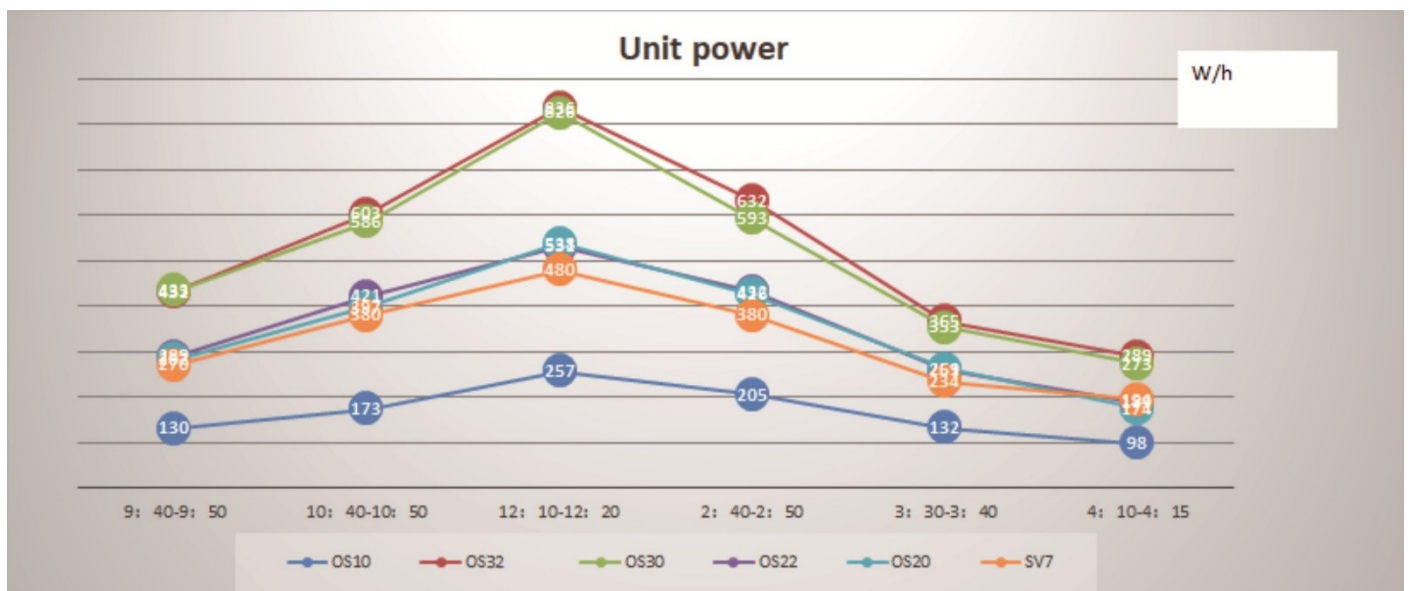

Test video for OS10 VS OS32 VS OS30 VS OS22 VS OS20 VS SV7, made in 2018:
<https://youtu.be/E1ru1enuEnQ>

Passed strict international certification, products are trustworthy. The Solar Keymark, the main quality label for solar thermal



NO.: 011-752867 L

Solar Keymark

www.solarkeymark.org

The Solar Keymark is a voluntary third-party certification mark for solar thermal products, demonstrating to end-users that a product conforms to the relevant European standards and fulfills additional requirements. The Solar Keymark was developed by the European Solar Thermal Industry Federation (ESTIF) and CEN (European Committee for Standardisation) in close co-operation with leading European test labs and with the support of the European Commission. It is widely spread across the European market and beyond. **Note: The difference between the Solar Keymark and the CE-mark** The Solar Keymark is a quality label and the CE-mark just attests that the product fulfills minimum legal requirements according to specific European directives.



TÜV Report No.: 50152939-001/50152941-001

The TÜV Rheinland Group is a leading provider of technical services worldwide. Founded in 1872 and headquartered in Cologne, the Group employs 19,700 people. It generates annual revenues of EUR1.92 billion.

Thermal performance testing for solar air collector; Pressure drop test; Time constant test; Visual inspection; Internal pressure test; Rupture or collapse test; Stagnation temperature; Exposure test; External thermal shock; Internal thermal shock; Rain penetration; Freeze resistance; Mechanical load; Impact resistance test using steel ball; Final inspection. All above listed tests of the standard EN12975-1:2006+A1:2010 and ISO 9806:2017 were passed successfully in accordance with the criteria.



No.44 100 1888 0001

The TÜV NORD GROUP brings together the brands TÜV NORD, DMT, ALTER TECHNOLOGY and TÜVIT. Typical testing and TÜV services are expanded by offers in the fields of IT, Aerospace and natural resources. More than 10,000 employees work together as an active and vibrant team, equipped with a broad horizon of knowledge and the desire to provide peak performance in their disciplines. The TÜV NORD GROUP offers its services in more than 70 countries.

Advantage

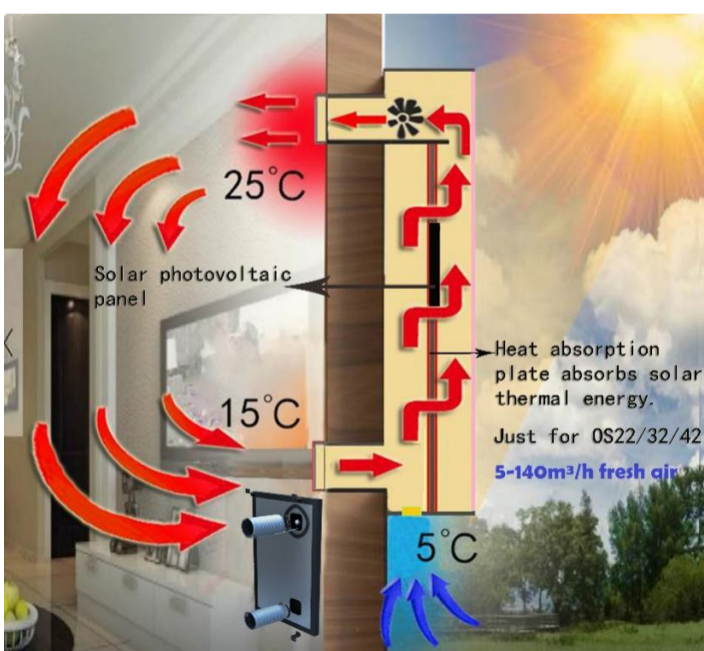
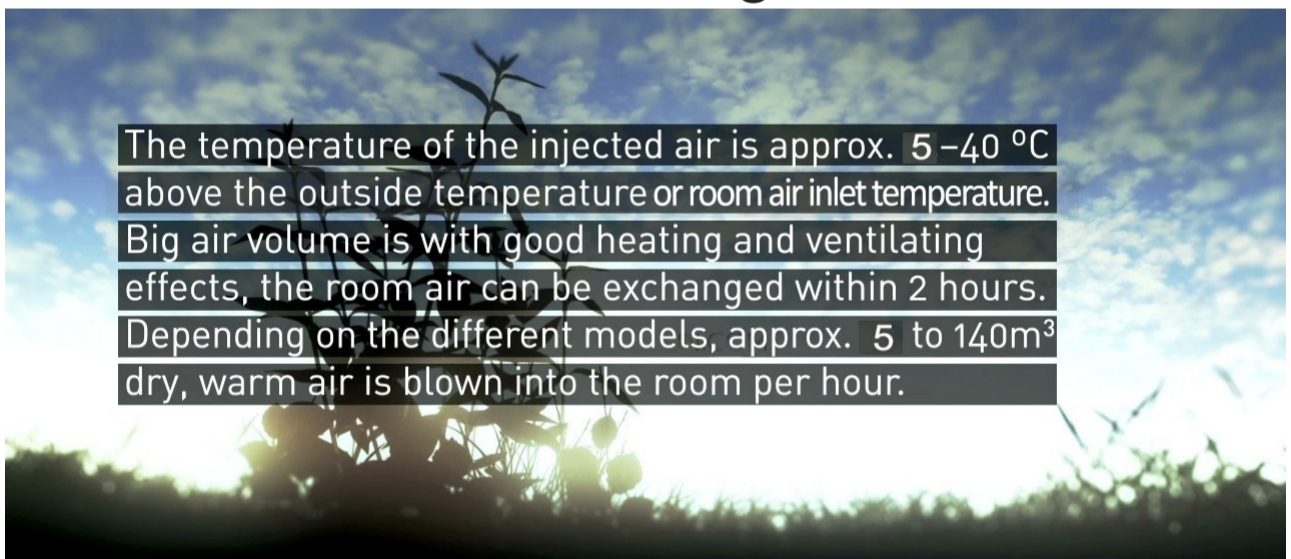

- **Heating indoor air mode**, can keep heating the room air, and keeps away from any wet or cold or smog air. When people at home or when in the winter morning, just open the room air inlet; when people out or at noon, close the room air inlet and introduce fresh air to ventilate and dehumidify.

For other models or other brands, the air speed will decrease when air pressure goes up, therefore, the efficiency of heating absorption will decrease. In case you open the window or some other gap to let air go out, but meanwhile, the heat will also be lost. So internal circulation mode is the most suitable for heating room air in the winter or cloudy day.

- **Special heating absorption board:**

Corrugated special anodic aluminum oxide, texture nano heat insulation coating, high absorption, low reflection. Solar absorbance of selective absorbing coating: 0.92; Hemisphere emittance of selective absorbing coating: 0.12.



- **Solar photovoltaic panels** are produced with well-known brand cell in high quality, high photoelectric conversion efficiency, low conversion efficiency attenuation rate, with life expectancy for 20 years. Collectors can be used to dry crops such as vegetables, fruits and grains. The service life of photovoltaic panels will not be affected even under high temperature and strong light in tropical and subtropical regions.



- Instead of hydraulic fan, **double ball fan** is adopted, with longer lifespan, low temperature resistant. SUNON from Taiwan is the most well-known fan brand in the world.

- Under sunlight, the air inside the OS collector flows along both sides of the heat absorbing plate and can absorb the heat well from the absorbing plate. Tested in $900W / m^2$ sunlight, when the air volume is the same, the temperature of the OS collector is $4\text{ }^\circ\text{C}$ higher than the collector where air flows only from one side of the heat absorbing plate.

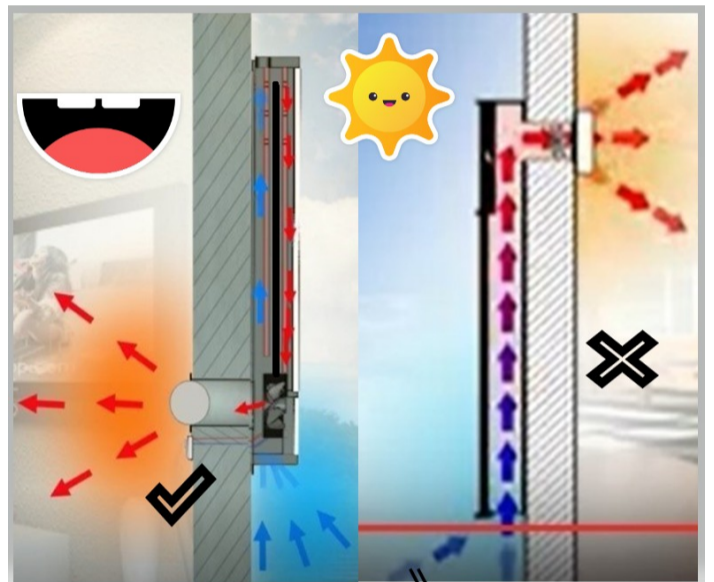

- Air outlet: it can be opened and closed manually or automatically, with 5mm thermal insulation cotton inside, good insulation effect. Automatically turns off when the fan is not running.



- Sealing strips are with high-quality silicone rubber: anti-UV, climate-resistance, better appearance. Frame: exclusively for open air, anti-UV texture coating, anti-UV outdoor screws.

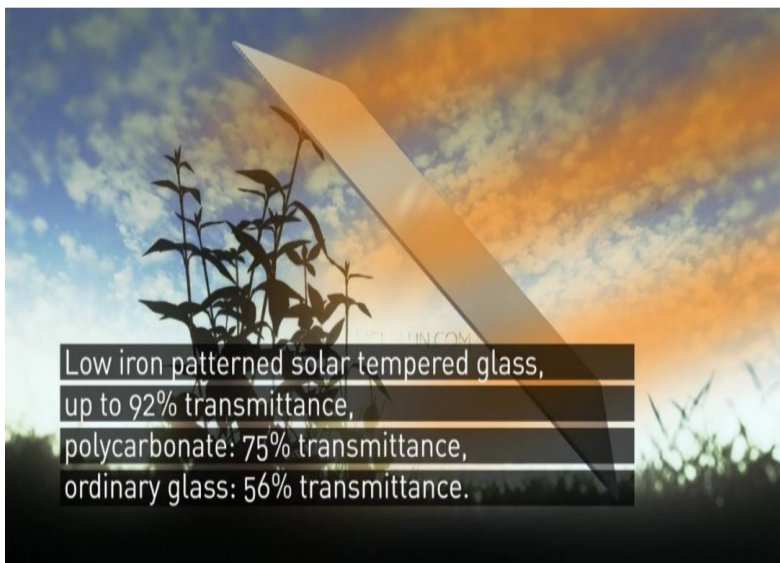

- Low iron solar tempered glass is with big intensity, high elasticity, the transmission is excellent. Lower diffuse reflection can prevent heat loss.

- ★ Fresh air inlet of solar air heater standard PET film: stops cold air, moisture, condensation of air humidity, and back draft (When not working).



OSCAR Warranty conditions

SUNON fan life expectancy: 70000 hours; 40000 hours warranty. Thermostat, air outlet can be replaced free of charge within 2 years. The lifespan for solar pv panel is 20 years, guaranteed for 10 years. While glass and aluminum materials are with long lifespan.



Easy installation, maintenance and operation

OS32, OS40/42 can be installed in 2 different directions.

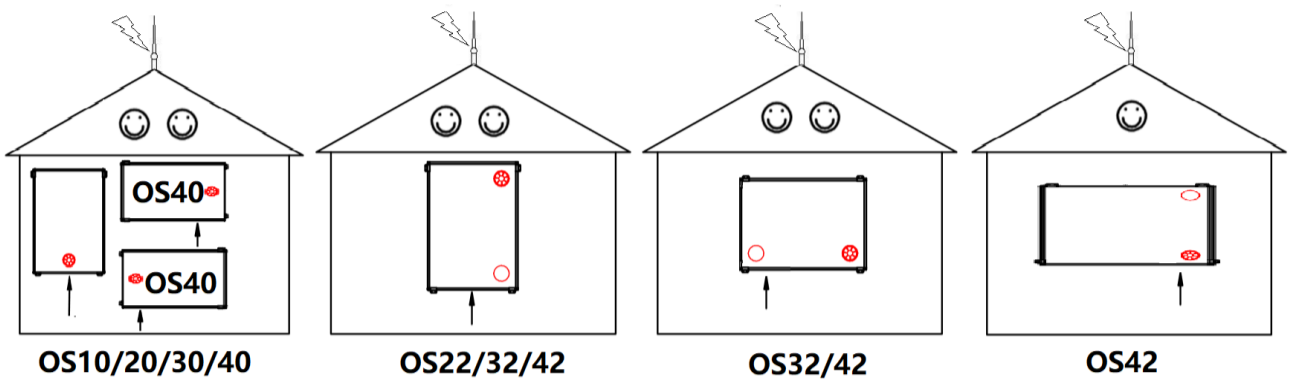

OS32+F11 H (Felt cover for horizontal installation)

Note that by setting up two panels, e.g. one facing east-southeast and one south-southwest, you can take full advantage of the available sunshine throughout the day.

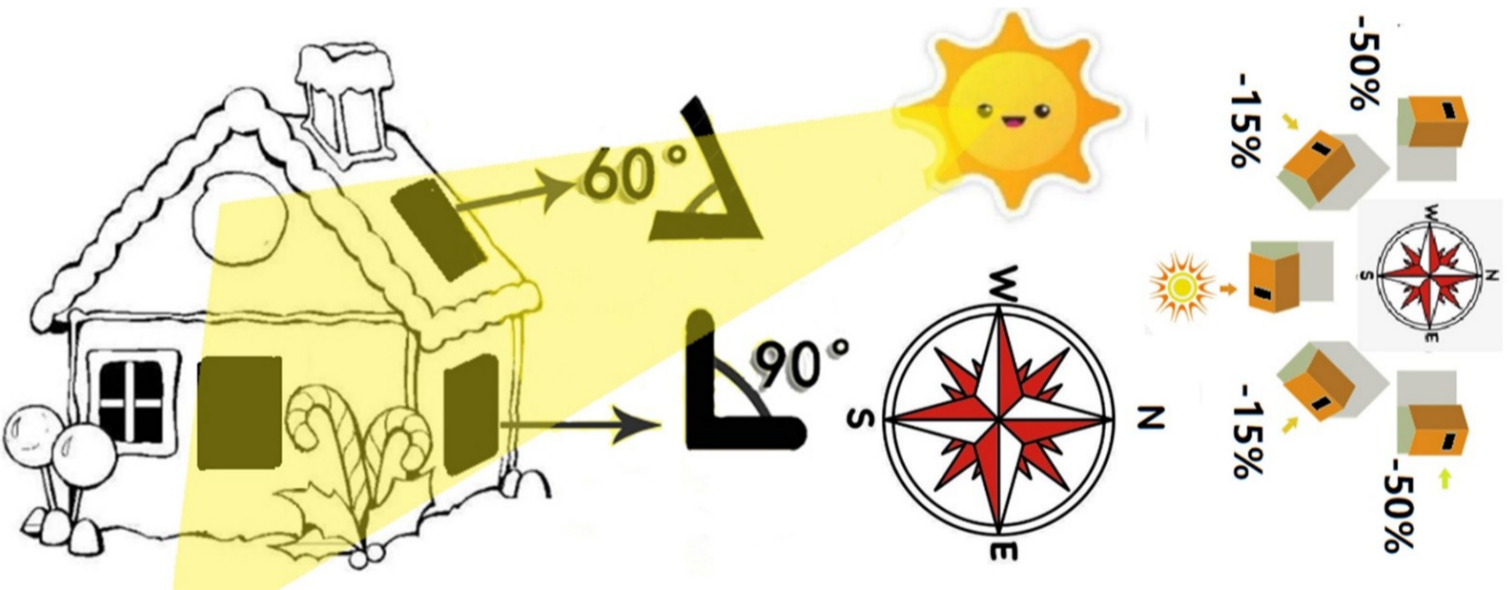

The solar air heater cannot raise the temperature of supply air or ventilate in these situations: If it's overcast, the sun isn't shining or is shining weakly, during the night, early in the morning or late at night and when the panel is covered by snow or ice or during rain.

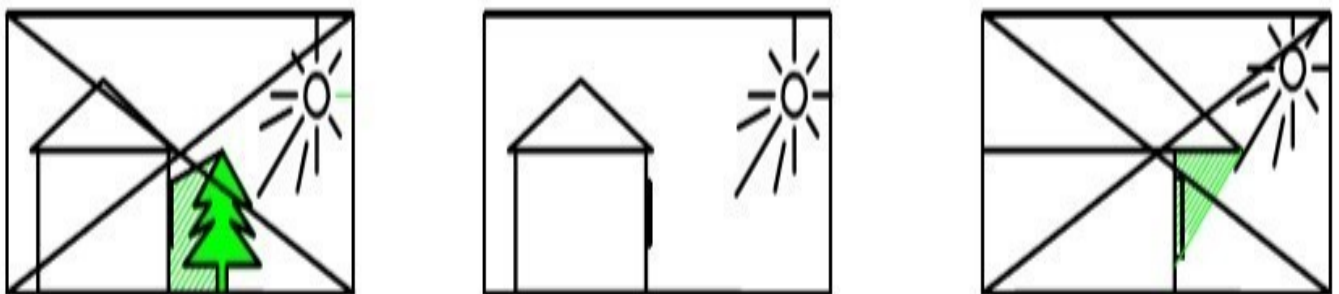

Can be installed on the wall or roof without the help of electrician/ construction worker. Small area, light weight. Installing your solar panel is so easy that you can do it yourselves. Product includes thermostat and all the necessary accessories for installation, such as screws, fixing clips, air ducts, air outlets, manuals, etc. Please distinguish wooden house and brick wall, so the correct electric drill is adopted. You can substitute the spare parts except solar pv panels all by yourself within 30 minutes, with easy tools like scissors, tape, screwdriver, etc.

OSCAR solar air collectors always provide you with a warm and healthy home

Wooden house tools:



If you want to increase the heating efficiency, please increase the wind speed, the heat loss will be reduced. Please turn down the air outlet, if you need air going to the room with higher temperature; Or feel too noisy.

Tips

- Glass panel is with 20 years life span, which is much longer than polycarbonate panels, which are only 10 years, and after sunlight irradiation, it becomes yellow and solar transmittance goes extremely lower.
- The felt gap used in the collector is easy to corrupt and fade after being exposed to open air for long term. If there is a lot of dust in the air, easy to be blocked. Felt gap is large, PM2.5 also cannot be filtered.
- The backside is installed on the wall without interval. Wall with good insulation prevent heat waste. There are several bugs and bias in Delta test. The samples are put against a ladder, without insulation of wall, so the testing temperature is lower than Oscar's actual performance. But some other brands bring in air at the backside, so the airflow can be bigger if there is no wall at the backside, and testing temperature would not decrease.



Transportation

If just 1-5pcs samples, it will be cheapest by express to your door. If about 10pcs, we can consider air transport to airport. It usually takes 7-10 days by air to airport or by express. Sea shipping will be much cheaper for larger order quantity. It usually takes 40 days to seaport.

Unpack the appliance and ensure that nothing is damaged and that all contents are present. If parcel arrives with serious damage, please contact express customer service before receipt, meanwhile please take pictures to retain evidence. In case of loss or damage for air delivery or sea shipment, we recommend ordering insurance. 20pcs/pallets for OS series.

Regarding the import duty rate, please consult your tax department according to HS code. [International Convention for Harmonized Commodity Description and Coding System \(HS code\)](#) for solar air heater:

8516293100 8419899090 8516299000 8543709990

Company introduction

Oscar Science & Technology Co., Ltd. is a professional manufacturer of solar air collector/ heater, solar ventilator etc.

We have got China invention patent certificate in April 2014. Patent number: ZL 2012 1 0230757.0. ISO9001 2015 certificate from German TUV NORD CERT since 2018, No.:44 100 1888 0001;

European Solar Keymark certification (ISO9806),
No.:011-7S2867 L; TÜV Rheinland test Report
No.: 50152941-001 &50152939-001.



A developing and testing lab is well established to test air volume, temperature difference of different models in different conditions, also insulation, UV-resistance, climate-resistance, water-proof to various materials such as coating and silicone.

We have innovatively adopted high-tech material like low iron ultra-pure glass and special texture nano insulation coating etc, and are dedicated to sustainable development and innovations, to ensure good quality and high performance.

Oscar solar air heaters are sold to many countries like UK, Denmark, Germany, Czech, Australia, New Zealand, Canada, America etc. In the past years, with continuous improvement and innovation, and focus on R&D, quality control, the Oscar solar air heater has won a good reputation due to its high performance and competitive price.

Users' comment

"After using OS22 air heater, we have cut our family heating bill by as much as 40%" ----Timur Mukhtarov, Russia

"The performance is unexpected. I actually didn't expect that much heating effect with such low price! When I put my hand at the air outlet, I can feel the heat and airflow pretty much! Thanks to OSCAR!" ----Alan Marutti, Italy

"We have saved 430 gallons last year with Oscar solar heater, which cut 35% of our heating bills. It's really great!" ----Tracey Ahlborn, USA



OSCAR solar air collectors always provide you with a warm and healthy home!

Avoid humidity Avoid stale smell Avoid mould and fungus

Contact us

Oscar Science & Technology Co., Ltd.

Email: alan@oscarsolar.com, info@solaroases.com

Web: www.oscarsolar.com www.solaroases.com

Address: No.5 Xing da 3rd Road, Yongkang, Zhejiang, China 321300

Tel: +86 13588619668 Fax: +86 579 88052015

Become OSCAR SOLAR Dealer

To interested dealers / installers:

OSCAR SOLAR is constantly looking for more dealers / installers around the world. The market for our product is large: not only for holiday homes, but also for many full-year houses, garages, basements, etc., which have problems with the indoor climate and who want to avoid far more expensive solutions, such as heat recovery plants / heat pumps, etc.

OSCAR solar air collectors always provide you with a warm and healthy home

We offer:

1. Extremely satisfied customers and the opportunity for good earnings, also in the long term. We will fully protect dealers' profits, create an independent brand: OASES SOLAR, sell strictly according to website prices (www.solaroases.com), and allow distributors to set their own prices and set up their own websites and brands locally.
2. Practical help with marketing. We will add the distributor's contact information and address on the website (www.solaroases.com). Consumers can easily contact nearby dealers. Can be translated into native language through Google Translate plugin.
3. If order quantity is more than 50pcs, we may give 5% discount. If order quantity is more than 100pcs, 8% discount. If order quantity is more than 200pcs, 12% discount.
4. For most customers in the European Union, the goods can be delivered to your door with very low freight, including customs clearance fees and duties, as long as payment is made 2 months in advance. Even if it's 2 units, the freight is just 90USD for 1pc OS20/22; the freight is just 1pc 140USD for OS30/32. A discount is also available for large quantities purchased at one time.
5. High solar subsidy from www.bafa.de for OS22, OS32, OS42 in Germany. OS22 can get a basic subsidy of 140.00 euros; OS32 / 42 can get a basic subsidy of 280.00 euros. The application for the models is quite simple and can be done online.
6. US warehouses and Australian warehouses are also planned, and customers in the Americas and Australia can purchase at very low shipping rates, as long as they book in advance.
7. It is even possible to store the goods in our warehouse in Germany and send the goods directly to the customer's house. If the ordered goods can't be sold, OSCAR SOLAR can buy them back at a 30% discount.

We require:

- Please inform us of the population and area of the distribution area, planned sales volume, number of in-channel sales outlets, Capital investment plan, marketing promotion plan, advertising plan, etc.
- Please let us know your requirements, such as advertising, how to protect your sales and



profits, etc.



OSCAR solar air collectors always provide you with a warm and healthy home